

CATALOG
OUTDOOR



CATALOG
OUTDOOR





VISION

With our range of products, we are specifically focusing on the ecological aspects connected to a new lifestyle, where the outdoors symbolize being in touch with nature, where boundaries disappear and change. Our systems, working with renewable energy sources, are a valid answer to the need to preserve the world that we share with all living beings, to respect it and to keep it untouched.

MISSION

The legacy we have been carrying on for over thirty years is a centuries-old tradition, strongly connected to the Earth and its bounty. Our mission is loyal to the spirit of cultivating, ploughing, manuring, watering, and harvesting. Faithful to our model, we cultivate human relationships and coordinate production with harvest seasons – just as it happens in nature. This modus operandi helped us to create a design tailored to evolving markets, and consolidating an organic, consistent set of corporate ethics that creates value and opportunity.



ISOTHERMAL PERGOLA

E C L E **T** T I C A



Eclettica is a pergola with a false ceiling equipped with a membrane and panels aimed at reflecting sound waves on its walls. The roof is suitable for the installation of solar panels that produce energy from renewable sources.

Eclettica is a harmonic synthesis of different technologies, to meet the growing demand for ecological solutions, as well as the requirement for all-round comfort that satisfies all senses, from the acoustics to the visuals.

The sober, simple, and essential lines are the distinguishing feature of the product: Eclettica looks forward, witnessing encounters between communities and nature, generating precious renewable energy, and being an inspiration for moments of pure relaxation.

The warm colors and the mat finish, painted with high-resistance epoxy powder, improve the product's quality and durability,

giving Eclettica a cozy look that is in harmony with natural elements. The structure can be complemented with a number of accessories, such as sliding edging profiles with PVC or glass membranes and decorative drapes.



LOCATION
Italy

CUSTOMER
Private

YEAR
2023

ECLETTICA - GALLERY





TECHNICAL DETAILS



TYPE

Isothermal pergola
with fixed roof

MATERIALS

- Aluminum
- PVC

STRUCTURE'S VERSIONS

- Freestanding / wall mounted
- Modular setup

STRUCTURE'S COLOR

Smooth finish

● Special Grey

Matt-Rough finish

○ White Matt

● Dove-Grey Matt

● Dark-Brown Matt

ROOFING SHEET'S MATERIALS AND COLORS

• Soltis 96

• Soltis 99

○ White

096-8102

992044

● Champagne

096-1103

9950303

● Grey

096-2171

9952058

● Dove-Grey

096-2135

992135

- smooth or mat textured finish and RAL colors available upon request

- More colors available upon request

STRUCTURE DIMENSIONS

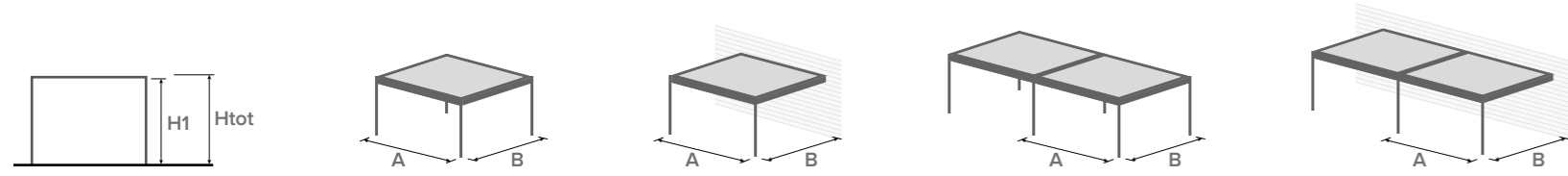

| A | B | H1 | Htot |
|-----|-----|-----|------|
| 300 | 300 | 240 | 266 |
| | | 300 | 326 |
| | 350 | 240 | 266 |
| | | 300 | 326 |
| | 400 | 240 | 266 |
| | | 300 | 326 |
| | 450 | 240 | 266 |
| | | 300 | 326 |
| | 500 | 240 | 266 |
| | | 300 | 326 |

| A | B | H1 | Htot |
|-----|-----|-----|------|
| 400 | 300 | 240 | 266 |
| | | 300 | 326 |
| | 350 | 240 | 266 |
| | | 300 | 326 |
| | 400 | 240 | 266 |
| | | 300 | 326 |
| | 450 | 240 | 266 |
| | | 300 | 326 |
| | 500 | 240 | 266 |
| | | 300 | 326 |

| A | B | H1 | Htot |
|-----|-----|-----|------|
| 500 | 300 | 240 | 266 |
| | | 300 | 326 |
| | 350 | 240 | 266 |
| | | 300 | 326 |
| | 400 | 240 | 266 |
| | | 300 | 326 |
| | 450 | 240 | 266 |
| | | 300 | 326 |
| | 500 | 240 | 266 |
| | | 300 | 326 |

| A | B | H1 | Htot |
|-----|-----|-----|------|
| 600 | 300 | 240 | 266 |
| | | 300 | 326 |
| | 350 | 240 | 266 |
| | | 300 | 326 |
| | 400 | 240 | 266 |
| | | 300 | 326 |
| | 450 | 240 | 266 |
| | | 300 | 326 |
| | 500 | 240 | 266 |
| | | 300 | 326 |

NAKED



PHOTOVOLTAIC PERGOLA

N A  K E D



Naked presents itself as a **photovoltaic pergola** with an essential and clean design, perfect for creating a welcoming outdoor area while simultaneously harnessing solar energy. It is the ideal solution to meet the growing needs for **renewable, autonomous, and sustainable energy production**.

Naked is a **support structure** for photovoltaic panels designed for the direct integration of any solar system available on the market, eliminating the need for additional structures.

Naked can be complemented with **optional** features such as a sliding waterproof sliding roof, LED lights, and perimeter closures.







TECHNICAL DETAILS

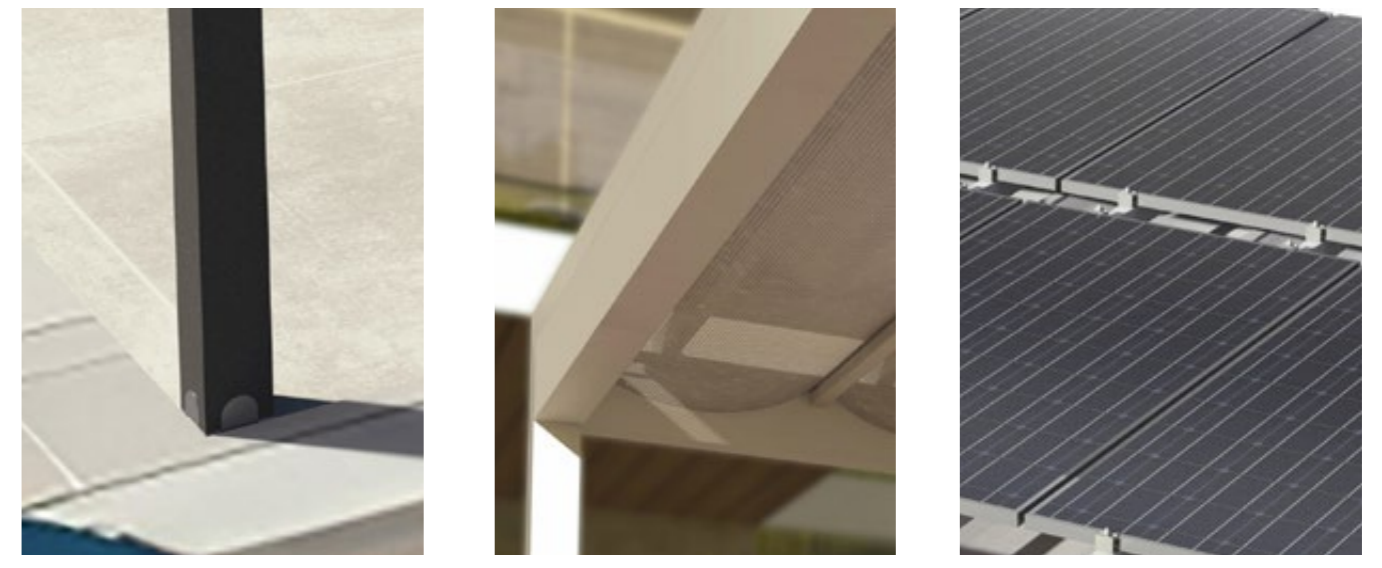

STRUCTURE'S COLOUR

- | | |
|----------------|-------------------|
| Smooth finish | Matt-Rough finish |
| ● Special Grey | ○ White Matt |
| | ● Dove-Grey Matt |
| | ● Dark-Brown Matt |

Further RAL colours available in both matt and glossy smooth finish

ROOFING SHEET'S MATERIALS AND COLORS

- White 60250537 • Preconstraint 602
- Champagne 60250539
- Grey 60250542
- Dove-Grey 60250597

- More colors available upon request

STRUCTURE DIMENSIONS

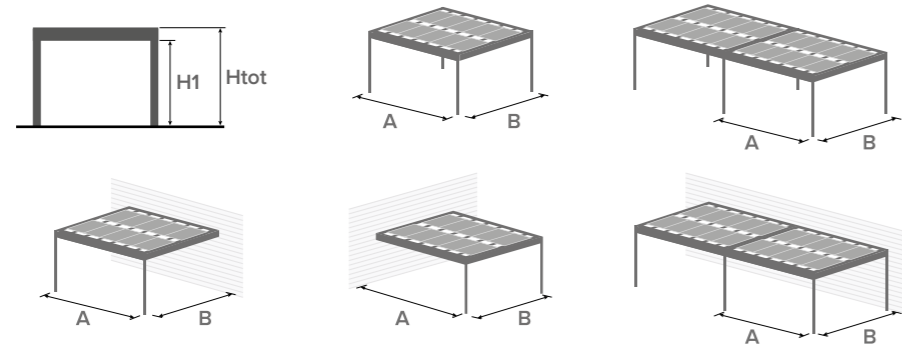

| A | B | H1 | Htot | A | B | H1 | Htot | A | B | H1 | Htot | A | B | H1 | Htot | | | | | | | | |
|-----|-----|-----|------|-----|-----|-----|------|-----|-----|-----|------|-----|-----|-----|------|-----|-----|-----|-----|-----|-----|-----|-----|
| 300 | 300 | 230 | 266 | 400 | 300 | 230 | 266 | 500 | 300 | 230 | 266 | 600 | 300 | 230 | 266 | | | | | | | | |
| | | 290 | 326 | | | 290 | 326 | | | 290 | 326 | | | 290 | 326 | | | | | | | | |
| | 350 | 350 | 230 | | 266 | 450 | 350 | | 230 | 266 | 550 | | 350 | 230 | 266 | 650 | 350 | 230 | 266 | | | | |
| | | | 290 | | 326 | | | | 290 | 326 | | | | 290 | 326 | | | 290 | 326 | | | | |
| | | 400 | 400 | | 230 | | 266 | | 400 | 400 | | | 230 | 266 | 400 | | 400 | 230 | 266 | 400 | 400 | 230 | 266 |
| | | | | | 290 | | 326 | | | | | | 290 | 326 | | | | 290 | 326 | | | 290 | 326 |
| | 450 | 450 | 230 | | 266 | 500 | 450 | | 230 | 266 | 550 | | 450 | 230 | 266 | 600 | 450 | 230 | 266 | | | | |
| | | | 290 | | 326 | | | | 290 | 326 | | | | 290 | 326 | | | 290 | 326 | | | | |
| | | 500 | 500 | | 230 | | 266 | | 500 | 500 | | | 230 | 266 | 500 | | 500 | 230 | 266 | 500 | 500 | 230 | 266 |
| | | | | | 290 | | 326 | | | | | | 290 | 326 | | | | 290 | 326 | | | 290 | 326 |
| | 350 | 300 | 230 | | 266 | 450 | 300 | | 230 | 266 | 550 | | 300 | 230 | 266 | 650 | 300 | 230 | 266 | | | | |
| | | | 290 | | 326 | | | | 290 | 326 | | | | 290 | 326 | | | 290 | 326 | | | | |
| 350 | | 350 | 230 | 266 | 500 | | 350 | 230 | 266 | 600 | | 350 | 230 | 266 | 700 | | 350 | 230 | 266 | | | | |
| | | | 290 | 326 | | | | 290 | 326 | | | | 290 | 326 | | | | 290 | 326 | | | | |
| | | 400 | 400 | 230 | | | 266 | 400 | 400 | | | 230 | 266 | 400 | | | 400 | 230 | 266 | 400 | 400 | 230 | 266 |
| | | | | 290 | | | 326 | | | | | 290 | 326 | | | | | 290 | 326 | | | 290 | 326 |
| 450 | | 450 | 230 | 266 | 550 | | 450 | 230 | 266 | 650 | | 450 | 230 | 266 | 750 | | 450 | 230 | 266 | | | | |
| | | | 290 | 326 | | | | 290 | 326 | | | | 290 | 326 | | | | 290 | 326 | | | | |
| | | 500 | 500 | 230 | | | 266 | 500 | 500 | | | 230 | 266 | 500 | | | 500 | 230 | 266 | 500 | 500 | 230 | 266 |
| | | | | 290 | | | 326 | | | | | 290 | 326 | | | | | 290 | 326 | | | 290 | 326 |

A R C A D I A



ARCADIA



ARCADIA-K

PERGOLA WITH SLACK FABRIC

A R C A D I A



The pergola with a manually operated sliding cover represents a timeless classic, the perfect fusion of form and function. Arcadia's minimal design, with essential lines, seamlessly blends with the surrounding environment, creating a space where landscape and architecture converge to ensure maximum comfort and relaxation.

Arcadia-K is the version with integrated perimeter guttering that channels rainwater inside the uprights, providing high protection against rain.

The presence of the cover and the gutter profile allows the installation of various types of walls in addition to the VOK wall, ranging from sliding ZIP walls to elegant glass walls. The warm color range and the matte finish of thermosetting epoxy powder coatings, oven-cured, enhance the product's quality and resistance to the effects of time, giving Arcadia a more welcoming appearance in harmony with natural elements.

The structure can be complemented with numerous accessories, such as the integrated LED light kit on the rafters, providing uniform and functional lighting to the entire space below.

Arcadia can be completed with a self-leveling floor composed of an aluminum frame and a choice of finish. The Horizon flooring can be weighted, eliminating the need for ground anchors.



MODEL
Arcadia-K

CUSTOMER
Levico Camping

YEAR
2024



MODEL
Arcadia

CUSTOMER
Lunardelli Tende

YEAR
2024



TECHNICAL DETAILS



TYOLOGY

Modern Pergola with Sliding Cover

MATERIALS

Aluminum structure
PVC cover
Stainless steel hardware

GROUND ANCHORING

Retractable inner feet

STRUCTURE VERSIONS

Freestanding / Wall-Mounted
Square / Rectangular
Modular Configuration

STRUCTURE'S COLORS

- White
- Dark brown
- Dove-Grey
- Special grey

- smooth or mat textured finish
- RAL colors available upon request

ROOF'S MATERIALS AND COLORS

- White
 - Grey
 - Champagne
 - Dove-Grey
- Soltis W96 (Dove-grey not available)
Precontraint 402
Precontraint 602 Blackout

- more colors available upon request

DIMENSIONS

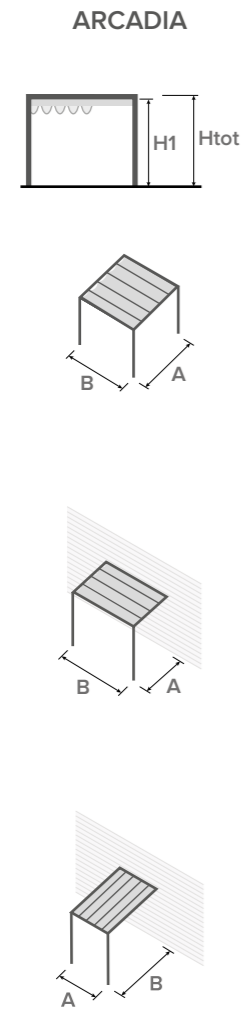

| ARCADIA | | | | | |
|---------|--------|------------------------|---------|-----------|-------------------|
| A (cm) | B (cm) | Area (m ²) | H1 (cm) | Htot (cm) | Number of purlins |
| 300 | 300 | 9 | 240 | 252 | 6 |
| | 400 | 12 | 240 | 252 | |
| | 500 | 15 | 240 | 252 | |
| 400 | 300 | 12 | 240 | 252 | 7 |
| | 400 | 16 | 240 | 252 | |
| | 500 | 20 | 240 | 252 | |
| 500 | 300 | 15 | 240 | 252 | 8 |
| | 400 | 20 | 240 | 252 | |
| | 500 | 25 | 240 | 252 | |
| 600 | 300 | 18 | 240 | 252 | 10 |
| | 400 | 24 | 240 | 252 | |
| | 500 | 30 | 240 | 252 | |

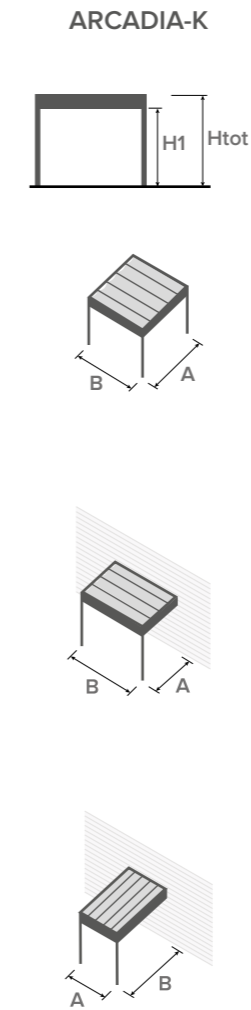

| ARCADIA-K | | | | | |
|-----------|--------|------------------------|---------|-----------|-------------------|
| A (cm) | B (cm) | Area (m ²) | H1 (cm) | Htot (cm) | Number of purlins |
| 300 | 300 | 9 | 240 | 282 | 8 |
| | 400 | 12 | 240 | 282 | |
| | 500 | 15 | 240 | 282 | |
| 400 | 300 | 12 | 240 | 282 | 10 |
| | 400 | 16 | 240 | 282 | |
| | 500 | 20 | 240 | 282 | |
| 500 | 300 | 15 | 240 | 282 | 12 |
| | 400 | 20 | 240 | 282 | |
| | 500 | 25 | 240 | 282 | |
| 600 | 300 | 18 | 240 | 282 | 15 |
| | 400 | 24 | 240 | 282 | |
| | 500 | 30 | 240 | 282 | |



MODERN DESIGN GAZEBO

Q Z **E** B O

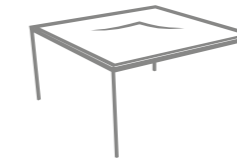

Qzebo is a one-of-a-kind modern gazebo. It revolutionized the clichéd dome shape, the classic spire, or round dome. With its almost linear roof, Qzebo represents a design never seen before. Qzebo is a reinterpretation of a gazebo, that leaves back traditions to mark the breaking point from the traditional archetype. Qzebo is the answer to the growing market demand for an innovative gazebo. The warm colors and the mat finish, hoven painted with high resistance epoxy powder, improve the product's resistance and make it a cozy-looking product, which sits in harmony with nature and the outdoors. The structure can be complemented with a number of accessories, such as the sliding edging profiles with PVC or glass membranes and decorative drapes. In order to optimize the comfort inside the structure, infrared heating and LED perimeter lighting are also available.



LOCATION
Italy

CUSTOMER
Clothing boutiques

YEAR
2023



Over a century ago, Mies van der Rohe came up with the concept “less is more”, creating a minimalist architectural language that nowadays is still a recognized and unmatched reference point. This view about design originates from the idea that the shape of a building, of an object, of a dress must not be the purpose of the planning: on the contrary, it should be the result of a process aimed at giving a simple response to a complex need. Long story short – the shape follows the function, not the other way around. It’s from this reflection that Qzebo was born: the perfect combination of simplicity and functionality. Qzebo encloses all that is needed to make a gazebo. Nothing more, nothing less.



LOCATION
Lido Estensi (Ferrara) - Italy

CUSTOMER
Bagno Prey

YEAR
2021



LOCATION
Lido Estensi (Ferrara) - Italy

CUSTOMER
Bagno Prey

YEAR
2021



TECHNICAL DETAILS



TYPE

Modern gazebo
for the outdoors

MATERIALS

Aluminum
PVC

GROUND ANCHORING

External or internal foot-
ing system

STRUCTURE'S VERSION

Freestanding
Squared/Rectangular

STRUCTURE'S COLORS

- White / RAL 9010
- Dark brown
- Dove-Grey
- Special grey

- smooth or mat textured finish
- RAL colors available upon request

ROOF'S MATERIALS AND COLORS

- White
- Champagne
- Grey
- Dove-Grey
- Preconstraint 502 Satin
- Preconstraint 602 Glossy
- Preconstraint 702-S2 Blackout

- more colors available upon request

STRUCTURE DIMENSIONS

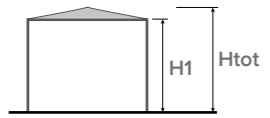

| A | B | H1 | Htot | AREA |
|-----|-----|-----|------|------|
| 300 | 300 | 250 | 300 | 9 |
| | | 300 | 350 | |
| 400 | 400 | 250 | 312 | 16 |
| | | 300 | 362 | |
| 500 | 500 | 250 | 324 | 25 |
| | | 300 | 374 | |

3 F A C I L E

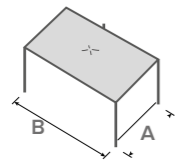
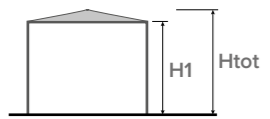

| A | B | H1 | Htot | AREA |
|-----|-----|-----|------|------|
| 300 | 400 | 250 | 308 | 12 |
| | | 300 | 358 | |
| 300 | 500 | 250 | 314 | 15 |
| | | 300 | 364 | |
| 400 | 500 | 250 | 319 | 20 |
| | | 300 | 369 | |



LEAN-TO PATIO VERANDA

3 F A C I L E

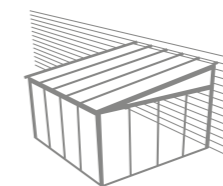

3Facile is a lean-to patio veranda with a fixed PVC cover. 3Facile revives the traditional shape of wooden pergolas, adding the aluminum and the PVC tarp's resistance and durability to get a space made to spend pleasant moments during any season. The warm colors and the mat finish, hoven painted with high resistance epoxy powder, improve the product's quality and its resistance, giving the structure a cozy look, in harmony with natural elements. The structure can be complemented with a number of accessories, such as the sliding edging profiles with PVC or glass membranes and decorative drapes.





LOCATION
Casale Monferrato, Alessandria, Italy

CUSTOMER
Sant'Antonio S.r.l.

YEAR
2020



TECHNICAL DETAILS



| TYPE | MATERIALS | GROUND ANCHORING | STRUCTURE'S VERSIONS |
|--------------------------------|-----------------|--|---|
| Aluminum lean-to patio veranda | Aluminum PVC | External footing system Internal footing system | Wall mounted Reinforced wall mounted |

STRUCTURE'S COLORS

- White
- Dark brown
- Dove-Grey
- Special grey

- smooth or textured finish
- RAL colors available upon request

ROOF'S MATERIALS AND COLORS

- White
- Grey
- Champagne
- Dove-Grey
- Soltis 96
- Preconstraint 402
- Preconstraint 602 Blackout

- more colors available upon request

STRUCTURE DIMENSIONS

STRUCTURE WITH 2 PILLARS

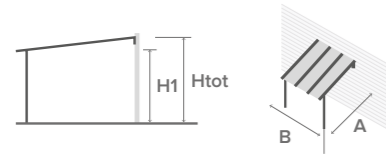

*It varies according to A and to the inclination of the top cover

**B indicates the width of the top cover

| A | B ** | | | H1 | Htot |
|-----|------|-----|-----|-----|------|
| 300 | 300 | 400 | 500 | 250 | * |
| 350 | 300 | 400 | 500 | 250 | * |
| 400 | 300 | 400 | 500 | 250 | * |
| 450 | 300 | 400 | 500 | 250 | * |
| 500 | 300 | 400 | 500 | 250 | * |

STRUCTURE WITH 3 PILLARS

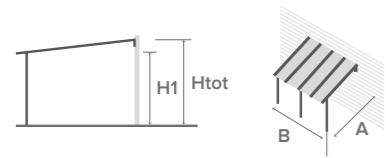

*It varies according to A and to the inclination of the top cover

**B indicates the width of the top cover

| A | B ** | | | | | | H1 | Htot |
|-----|------|-----|-----|-----|-----|------|-----|------|
| 300 | 500 | 600 | 700 | 800 | 900 | 1000 | 250 | * |
| 350 | 500 | 600 | 700 | 800 | 900 | 1000 | 250 | * |
| 400 | 500 | 600 | 700 | 800 | 900 | 1000 | 250 | * |
| 450 | 500 | 600 | 700 | 800 | 900 | 1000 | 250 | * |
| 500 | 500 | 600 | 700 | 800 | 900 | 1000 | 250 | * |

STRUCTURE WITH 4 PILLARS

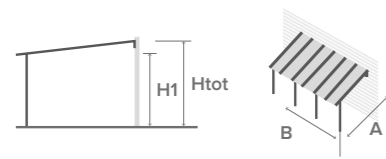

*It varies according to A and to the inclination of the top cover

**B indicates the width of the top cover

| A | B ** | | | H1 | Htot |
|-----|------|------|------|-----|------|
| 300 | 1000 | 1100 | 1200 | 250 | * |
| 350 | 1000 | 1100 | 1200 | 250 | * |
| 400 | 1000 | 1100 | 1200 | 250 | * |
| 450 | 1000 | 1100 | 1200 | 250 | * |
| 500 | 1000 | 1100 | 1200 | 250 | * |

K U B E



PERGOLA WITH INTERLACED ROOF

K U-B E

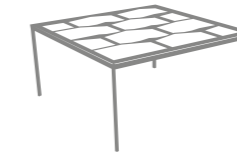

Kube can be defined as the nexus between contemporary design and the archetype of a house – the simplicity of a hut, built with intertwined elements that recall the most natural shading systems, made of branches and twigs.

The structure is a trellis criss-crossed by PVC tarps, its alternating movement breaking the monotony of plain surfaces and offering glimpses of the sky through the interweaving.

The structure can be complemented with a number of accessories such as curtains and decorative drapes. At night Kube fully manifests its beauty, thanks to the LED lights built into the perimeter beams that create a cozy and intimate atmosphere.



LOCATION
Saudi Arabia

CUSTOMER
Azimuth Festival

YEAR
2020



Kube represents a stylistic exercise, typical of strategic design. While designing it, we wanted to catch glimpses of life through perceptive and environmental features. Kube's formal and dimensional diversity shows itself through the heterogeneous heights and the volumetric modular construction – a signature feature that becomes a means of urban and residential regeneration. The goal is to connect parts of the building or of the botanical surroundings to the pergola, becoming thus the unifying element of the space. Kube harmonizes with any kind of surrounding, giving the chance to have a panoramic vision of space that multiplies the different perceptions of harmonic beauty.



LOCATION
Abu Dhabi

CUSTOMER
Arena

YEAR
2024



TECHNICAL DETAILS

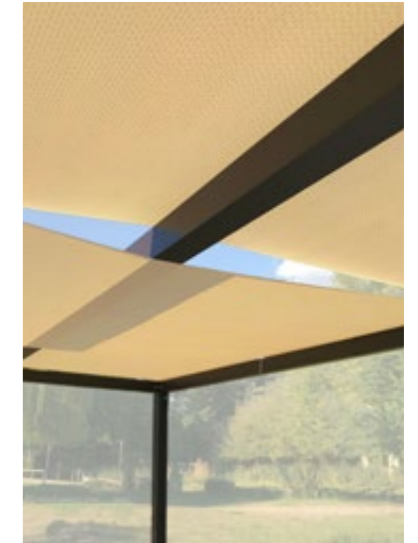
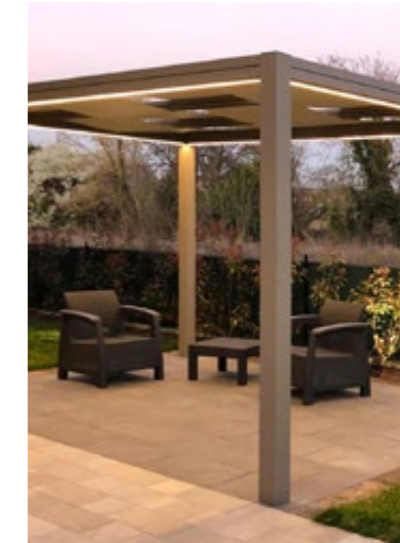

TYPE

Shading canopy
with interlaced
PVC fabric roof

MATERIALS

Aluminum
PVC

GROUND ANCHORING

External footing system
Internal footing system
Sand footing system

STRUCTURE'S VERSIONS

Freestanding/Wall mounted
Square/Rectangular
Modular configuration
Kube 90 / Kube 120

STRUCTURE'S COLORS

○ White ● Dove-Grey
● Dark brown ● Special grey

- smooth or textured mat finish
- RAL colors available upon request

ROOF'S MATERIALS AND COLORS

○ White ● Champagne Soltis 96
● Grey ● Dove-Grey Soltis W96 (Dove-Grey not available)
Precontraint 402
Precontraint 602 Blackout

- more colors available upon
request

STRUCTURE DIMENSIONS

KUBE 90



KUBE 120

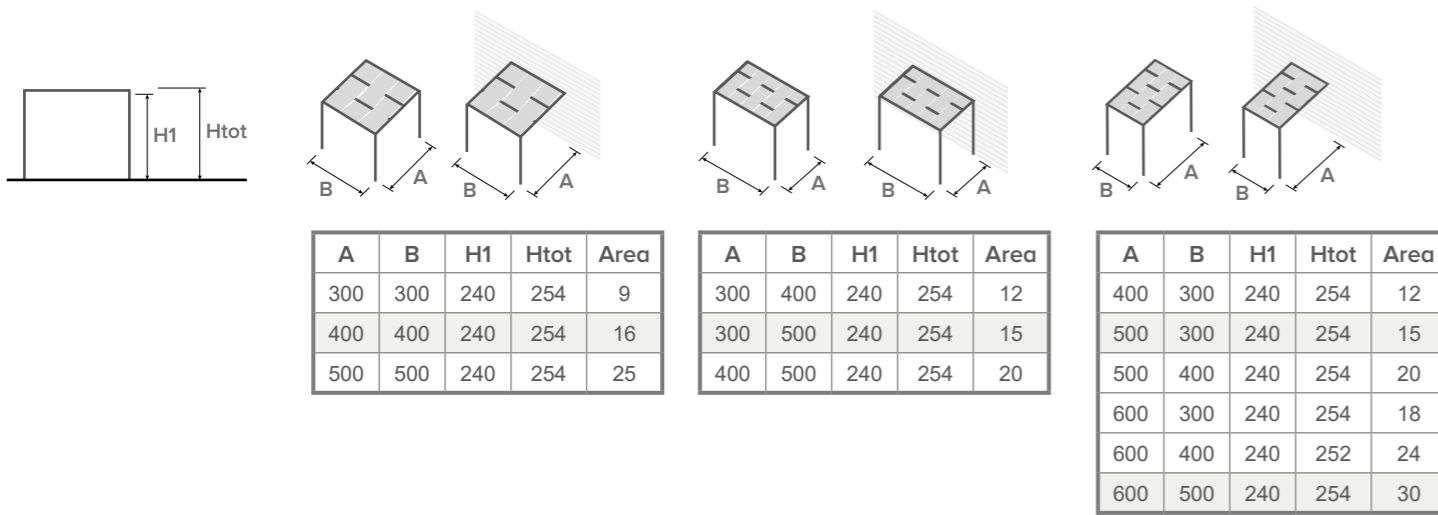

- Configuration with additional modules for the Kube 120 model

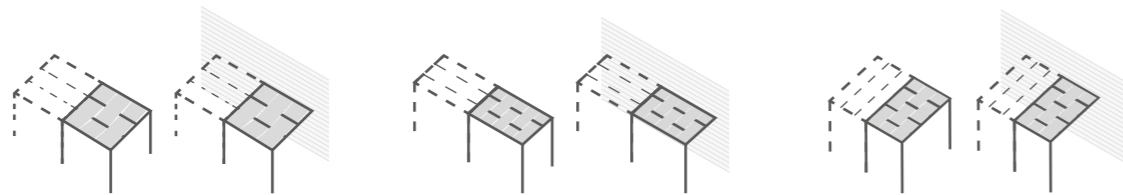



PERGOLA WITH RETRACTABLE AWNING

O N D A



Onda is a freestanding or wall mounted pergola with a manually-operated sliding tarp cover. Its design is all about simplicity, in each and every detail: the result is a contemporary pergola that suits walls with perimetric openings. Establishing a strong and stable relation between indoor and outdoor spaces and offering a pleasant space for comfort and relaxation, Onda is the link between landscape and architecture. The warm colors and the mat finish, hoven painted with high resistance epoxy powder, improve the Onda's resistance in time and make it a cozy-looking product, that sits in harmony with nature and the outdoors. The structure can be complemented with a number of accessories, such as the sliding edging profiles with PVC or glass membranes, curtains, telescopic windshields made of glass and a LED lighting kit.



LOCATION
Seoul, South Korea

CUSTOMER
Private

YEAR
2022



Onda represents the perfect symbiosis between structural elements and outdoor spaces. The pitched cover made with a PVC membrane can be expanded, thanks to a modular system that finds no limit in space. The thought behind the design comes from the need to reduce complexity in favor of a simplification of the whole system.

Onda is a very manageable structure, thanks to its intuitive simplicity. The sophistication of the volumes, of the materials and of the chromatisms blends into new, minimal shapes – thanks to them, any architectural design absorbs Onda's timeless style, making the volumes and the structural elements impalpable, promoting simplicity, and acquiring a complex and advanced design.



LOCATION
France

CUSTOMER
Private

YEAR
2023



TECHNICAL DETAILS

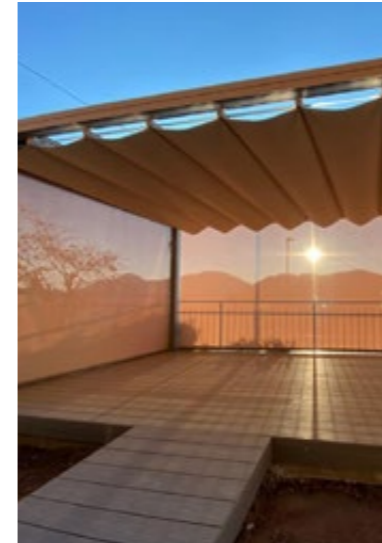

TYPE

Contemporary pergola
with retractable awning

MATERIALS

Aluminum
PVC

GROUND ANCHORING

External footing system
Internal footing system
Sand footing system

STRUCTURE'S VERSIONS

Freestanding/Wall mounted
Square/Rectangular
Modular configuration

STRUCTURE'S COLORS

○ White ● Dove-Grey
● Dark brown ● Special grey

ROOF'S MATERIALS AND COLORS

○ White ● Champagne Soltis 96
● Grey ● Dove-Grey Soltis W96 (Dove-grey not available)
Preconstraint 402
Preconstraint 602 blackout

- smooth or mat textured finish
- RAL colors available upon request

- more colors available upon request

ONDA 90

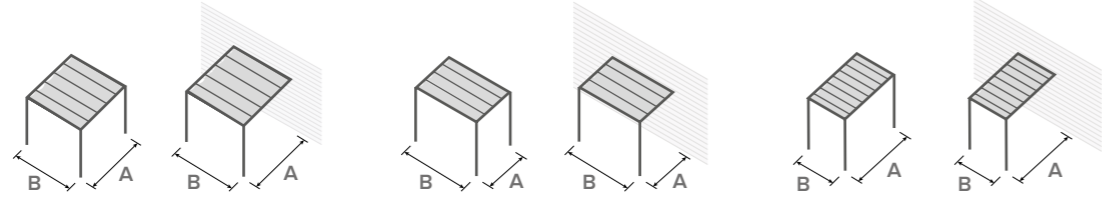
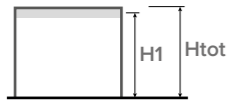

| A | B | H1 | Htot | Area |
|-----|-----|-----|------|------|
| 300 | 300 | 240 | 250 | 9 |
| 400 | 400 | 240 | 250 | 16 |

| A | B | H1 | Htot | Area |
|-----|-----|-----|------|------|
| 300 | 400 | 240 | 250 | 12 |

| A | B | H1 | Htot | Area |
|-----|-----|-----|------|------|
| 400 | 300 | 240 | 250 | 12 |

ONDA 120

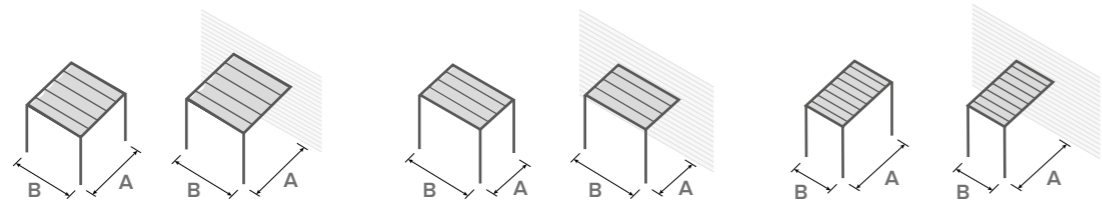
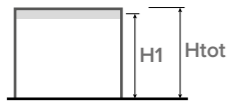

| A | B | H1 | Htot | Area |
|-----|-----|-----|------|------|
| 300 | 300 | 240 | 254 | 9 |
| 400 | 400 | 240 | 254 | 16 |
| 500 | 500 | 240 | 254 | 25 |

| A | B | H1 | Htot | Area |
|-----|-----|-----|------|------|
| 300 | 400 | 240 | 254 | 12 |
| 300 | 500 | 240 | 254 | 15 |
| 400 | 500 | 240 | 254 | 20 |

| A | B | H1 | Htot | Area |
|-----|-----|-----|------|------|
| 400 | 300 | 240 | 254 | 12 |
| 500 | 300 | 240 | 254 | 15 |
| 500 | 400 | 240 | 254 | 20 |
| 600 | 300 | 240 | 254 | 18 |
| 600 | 400 | 240 | 254 | 24 |
| 600 | 500 | 240 | 254 | 30 |

Configurations with additional modules only for Onda 120 model

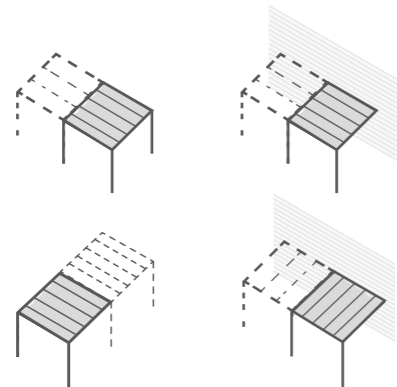



PERGOLA WITH SHADE SAIL

V E L A



Vela is a pergola with a manually-operated roll-up double shading sail that combines the austere shape of a cube with the extremely free and dynamic shape of a sail – the result is a product that perfectly matches any type of architecture, without spoiling the harmony of the spaces. Vela pushes the boundaries, the transition being represented by the sail, and invites to indulge in meditation. The warm colors and the mat finish, hoven painted with high resistance epoxy powder, improve the Onda's resistance in time and make it a cozy-looking product, which sits in harmony with nature and the outdoors. The structure can be complemented with a number of accessories, such as curtains and decorative drapes.



LOCATION
Abu Dhabi

CUSTOMER
Arena

YEAR
2024



LOCATION
Italy

CUSTOMER
Buena Onda Resort

YEAR
2022



TECHNICAL DETAILS

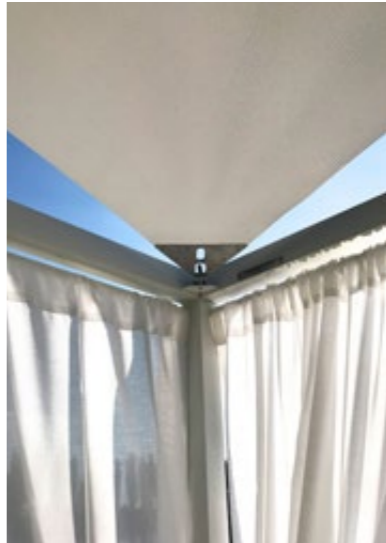
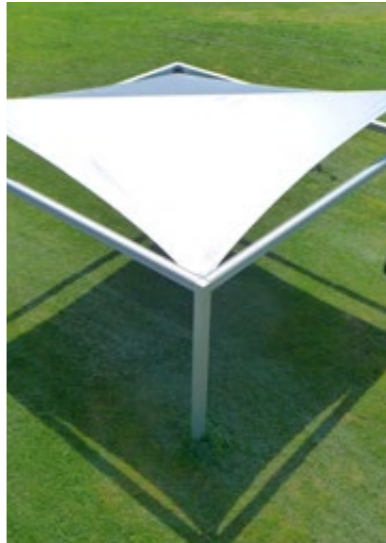

| TYPE | MATERIALS | GROUND ANCHORING | STRUCTURE'S VERSIONS |
|-------------------------|-----------------|---|------------------------------------|
| Pergola with shade sail | Aluminum PVC | External footing system Internal footing system Sand footing system | Freestanding Vela 90 / Vela 120 |

STRUCTURE'S COLORS

- White
- Dove-Grey
- Dark brown
- Special grey

- smooth or mat textured finish
- RAL colors available upon request

ROOF'S MATERIALS AND COLORS

- White
- Champagne
- Grey
- Dove-Grey
- Soltis 96
- Soltis W96 (Dove-grey not available)
- Precontraint 402
- Precontraint 602 blackout

- more colors available upon request

VELA 90

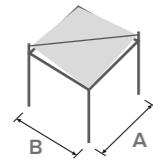
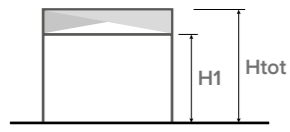

| A | B | H1 | Htot | Area |
|-----|-----|-----|------|------|
| 300 | 300 | 240 | 297 | 9 |
| 400 | 400 | 240 | 314 | 16 |

VELA 120

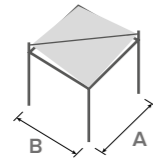
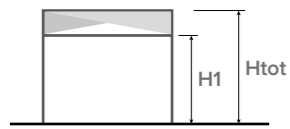

| A | B | H1 | Htot | Area |
|-----|-----|-----|------|------|
| 300 | 300 | 240 | 287 | 9 |
| 400 | 400 | 240 | 304 | 16 |
| 500 | 500 | 240 | 321 | 25 |

VELORA



MINIMALIST SHADE SAIL

V E L O R A

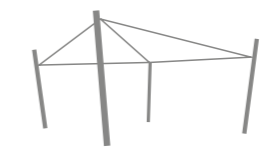

Velora is a shading sail, dedicated to those who love sailing-inspired designs – the winches and the stoppers used for the manual rewinding of both triangular sails and the inclined aluminum pillars with an elliptical section give the structure the dynamic and high-tech feel of a sail boat. Velora has a central roller with a spring-assisted rewinding system, facilitating the manual opening and closure of the sails. The structure can be installed anywhere in a very short time, even without preparing a foundation, thanks to an elegant ballast in white stone grit.



Velora, a design between art and science, at the edge between remembrance and invention.

Velora has the courage of modernity and the prudence and tradition, awakening emotions that arise from the circular process of designing and creating, coming back to the original idea.

Velora mixes styles and disciplines, includes similarities without modifying the territory, but melting with it, making it cozy and pleasant.



LOCATION
S. Pelagio, Trieste, Italy

CUSTOMER
Agriturismo Terra del Carso

YEAR
2018



TECHNICAL DETAILS

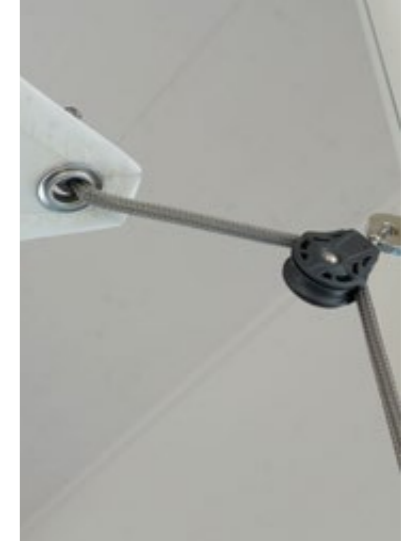
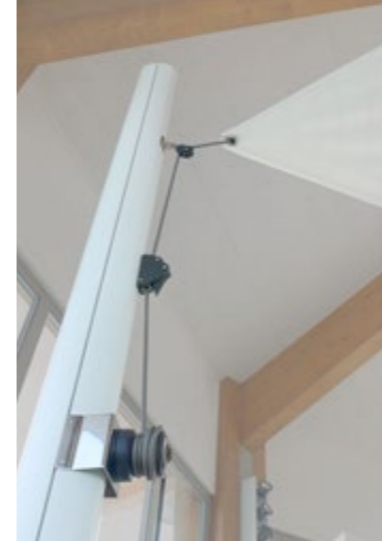

TYPE

Shade sail
for the garden

MATERIALS

Aluminum
Dacron

GROUND ANCHORING

Welded plate

STRUCTURE'S VERSIONS

With roller
Tensioning system attached to
the wall

STRUCTURE'S COLOR

- White/ RAL 9010
- Dove-Grey
- Dark brown
- Special grey
- Anodized silver

ROOF'S MATERIALS AND COLORS

- White
- Beige
- Dacron

- smooth or mat textured finish
- RAL colors available upon request

- more colors available upon request

STRUCTURE DIMENSIONS

SQUARE STRUCTURE

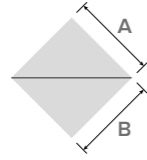
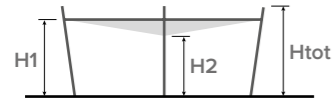

| A | B | H1 | H2 | Htot | Area |
|-----|-----|-----|-----|------|------|
| 400 | 400 | 286 | 250 | 300 | 16 |
| 450 | 450 | 286 | 250 | 300 | 20,3 |
| 500 | 500 | 286 | 250 | 300 | 25 |

RHOMBOIDAL STRUCTURE

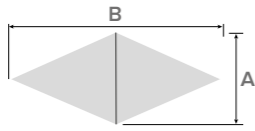
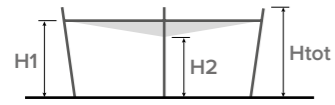

| A | B | H1 | H2 | Htot | Area |
|-----|------|-----|-----|------|------|
| 400 | 600 | 286 | 250 | 300 | 12 |
| | 800 | 286 | 250 | 300 | 16 |
| 500 | 800 | 286 | 250 | 300 | 20 |
| | 1000 | 286 | 250 | 300 | 25 |
| 600 | 800 | 286 | 250 | 300 | 24 |
| | 1000 | 286 | 250 | 300 | 30 |

V E L A R T



TRIANGULAR SHADE SAIL

V E  A R T

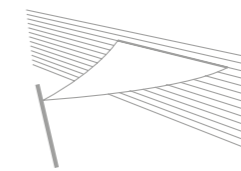

Velart is a wall mounted sail that highlights spaces with its dynamic shape, suitable to gardens as well as Horeca spaces. Its design is inspired by sailing: the inclined pillar in stainless steel, the winch and the stopper used for the manual rewinding of the sail recall the technical features and the strength of the ropes used in sailing boats, and the discreet charme of the sea.

Velart has a spring-assisted rewinding system, facilitating the manual opening and closure of the sail. The structure can be installed anywhere in a very short time, even without preparing a foundation, thanks to an elegant ballast in white stone grit.



Velart is a shading system that represents the perfect style balance between contemporary and futuristic design, combining the structural resistance with the style of the whole design. Velart wraps spaces and things up in an impalpable way, creating coziness and facilitating the relations amongst the users, as well as their connection with the nature and the surroundings.





TECHNICAL DETAILS

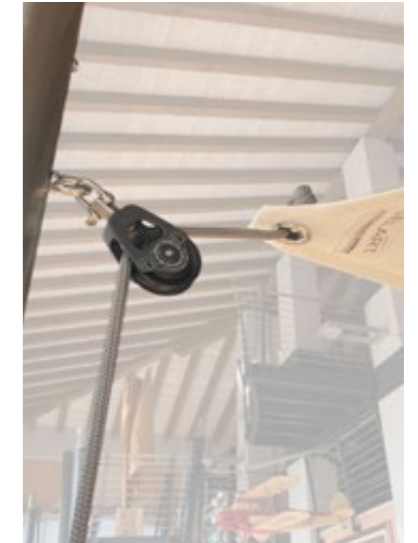

TYPE

Shade sail
for the garden

MATERIALS

Aluminum
Stainless steel
Dacron

GROUND ANCHORING

Welded plate

STRUCTURE'S VERSIONS

Tensioning system attached
to the wall

STRUCTURE'S COLORS

Brushed stainless steel AISI 316

ROOF'S MATERIALS AND COLORS

White Beige Dacron

- more colors available upon request

STRUCTURE DIMENSIONS

TRIANGULAR STRUCTURE

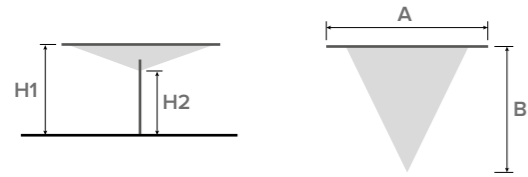

| A | B | H1 | H2 | Area |
|-----|-----|-----|-----|------|
| 300 | 300 | 286 | 250 | 4,5 |
| 350 | 300 | 286 | 250 | 5,3 |
| 400 | 300 | 286 | 250 | 6 |
| | 400 | 286 | 250 | 8 |
| 500 | 400 | 286 | 250 | 10 |
| | 500 | 286 | 250 | 12,5 |
| 600 | 500 | 286 | 250 | 15 |
| | 600 | 286 | 250 | 18 |

ALBATRO



DESIGN PERGOLA

A L B A T R O

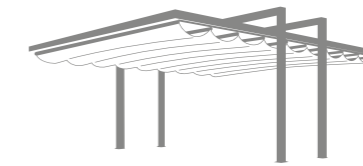

This model is made for freedom lovers. Its name is inspired by the albatross, a symbol of neverending loyalty to one's own identity and of the ability to look beyond.

Light, floating in space, with no angled columns: Albatro stretches out towards open spaces.

A design pergola with a cantilevered sliding top posing on four central pillars, to be anchored to a stable base or to be fixed to end supports in reinforced concrete.



LOCATION
Milan

CUSTOMER
Milano CityLife -Fuorisalone

YEAR
2020



Albatro is one of the most poetic and ambitious project in Giulio Barbieri's Pergole&Vele line. Its design stems from seeking a balance between functionality and beauty. Albatro fully symbolizes the sense of freedom and the ability to rise up and fly high. With incredible lightness and harmony, it blends easily into any environment, even the urban one, adding a modern touch without being in contrast with the surroundings.



LOCATION
Manakara Beach, Teramo, Italy

CUSTOMER
Fabbi Tende S.r.l.

YEAR
2018



TECHNICAL DETAILS

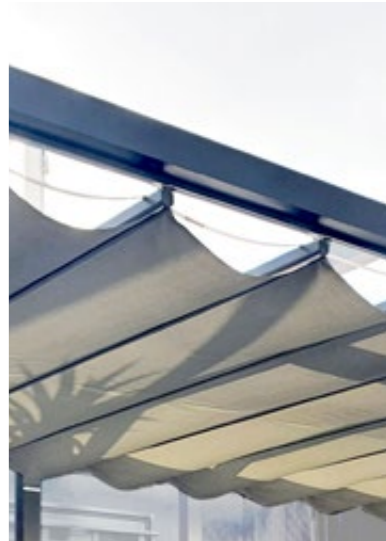

| TYPE | MATERIALS | GROUND ANCHORING | STRUCTURE'S VERSION |
|--------------------------------------|-------------------|---|---------------------------|
| Design pergola with retractable roof | Alluminium PVC | External footing system Internal footing system Concrete ballasts | Freestanding/Wall mounted |

STRUCTURE'S COLORS

- White
- Dark brown
- Dove-Grey
- Special grey

- smooth or mat textured finish
- RAL colors available upon request

ROOF'S MATERIALS AND COLORS

- White
- Champagne
- Grey
- Dove-Grey
- Soltis 96
- Soltis W96 (Dove-grey not available)
- Preconstraint 402
- Preconstraint 602 blackout

- more colors available upon request

STRUCTURE DIMENSIONS

FREESTANDING STRUCTURE

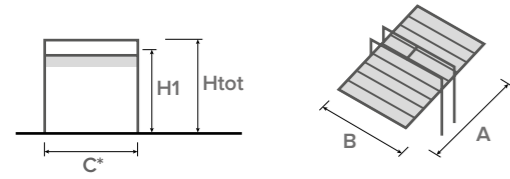

| A | B | H1 | Htot | Area |
|-----|-----|-----|------|------|
| 500 | 300 | 250 | 296 | 15 |
| | 400 | 250 | 296 | 20 |
| | 500 | 250 | 296 | 25 |
| 600 | 300 | 250 | 296 | 18 |
| | 400 | 250 | 296 | 24 |
| | 500 | 250 | 296 | 30 |

*C indicates the overall frontal dimension with plates: B + 28 cm

WALL MOUNTED STRUCTURE

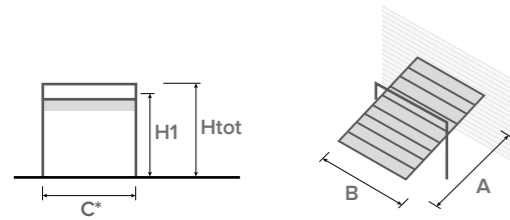

| A | B | H1 | Htot | Area |
|-----|-----|-----|------|------|
| 500 | 300 | 250 | 296 | 15 |
| | 400 | 250 | 296 | 20 |
| | 500 | 250 | 296 | 25 |
| 600 | 300 | 250 | 296 | 18 |
| | 400 | 250 | 296 | 24 |
| | 500 | 250 | 296 | 30 |

*C indicates the overall frontal dimension with plates: B + 28 cm

The wall mounted structure has only one pillar

OPTIONALS

OPTIONALS

HORIZON
wooden floor

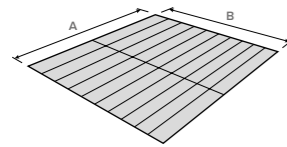
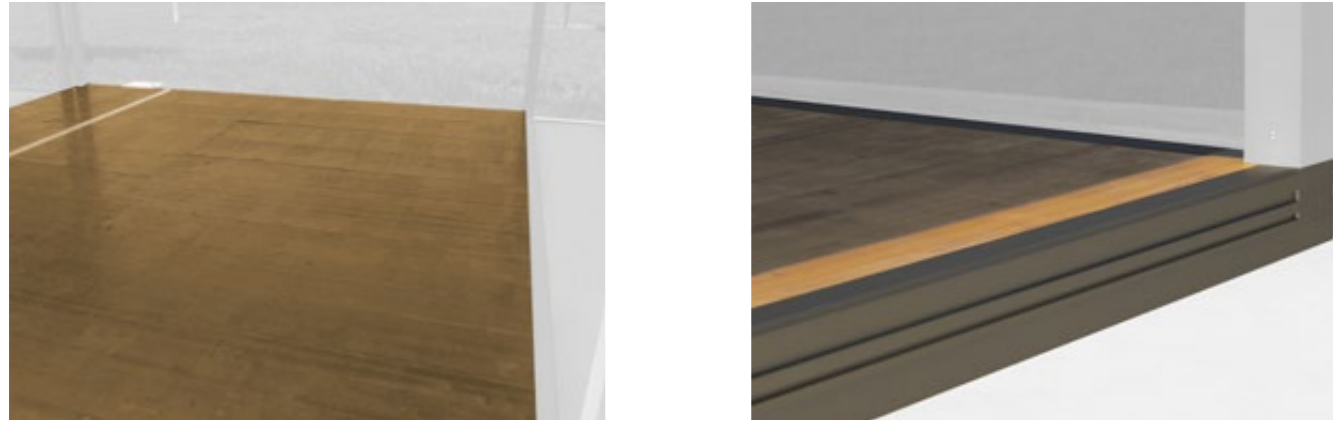

| | | | | | | | | | | | |
|---|-----|-----|-----|-----|-----|-----|-----|-----|-----|-----|-----|
| A | 300 | 300 | 300 | 400 | 400 | 400 | 400 | 500 | 500 | 500 | 600 |
| B | 300 | 400 | 500 | 400 | 300 | 400 | 500 | 300 | 400 | 500 | 500 |

STRUCTURE'S COLORS

- White/ Ral 9010
- Dove-Grey
- Dark brown
- Special grey
- Anodized silver

- smooth or mat textured finish
- RAL colors available upon request

FLOOR'S COLORS AND MATERIALS & STRUCTURE'S VERSIONS

- Spruce wood
- Free floating
- Floating with anchorage for the installment of the structures

- more colors available upon request

COMPATIBLE WITH:

Eclettica | Arcadia | Arccadia-K | Qzebo | Kube 90 | Kube 120 | Onda 90 | Onda 120 | Vela 90 | Vela 120

PVC WALL
side opening



WALL VERSIONS

Plain



With windows

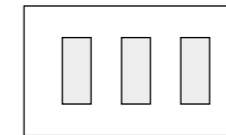

Mesh



COLORS OF THE PVC

- White
- Champagne

PVC TYPES

Precontraint 602

COLORS OF THE PVC

- White
- Champagne
- Grey
- Dove-Grey

PVC TYPES

Soltis 96

COMPATIBLE WITH:

Qzebo | 3Facile | Kube 90 | Kube 120 | Onda 90 | Onda 120 | Vela 90 | Vela 120

PVC WALL
central opening



WALL VERSIONS

Plain

With windows

Mesh

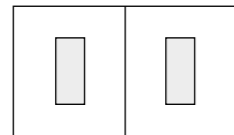
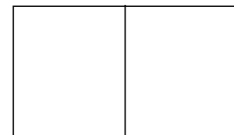

COLORS OF THE PVC

○ White ● Champagne

COLORS OF THE PVC

○ White ● Champagne
● Grey ● Dove-Grey

PVC TYPES

Precontraint 602

PVC TYPES

Soltis 96

COMPATIBLE WITH:
Qzebo | Kube 90 | Kube 120 | Onda 90 | Onda 120 | Vela 90 | Vela 120

PVC WALL
vertical zipper closure

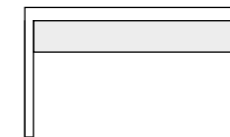

STRUCTURE'S COLORS

○ White mat ● Dove-Grey mat
● Dark brown mat ● Special grey

COLORS OF THE PVC

○ White ● Champagne
● Grey ● Dove-Grey

PVC TYPES

Cristalplus 500
Soltis W96 (Dove-grey not available)
Precontraint 502

COMPATIBLE WITH:
Arcadia-K | Eclettica | Qzebo | 3Facile

VOK WALL
roller blind closure

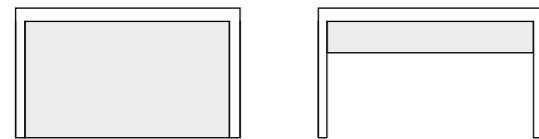

- Soltis 96 lining sheet
- Crank handle

STRUCTURE'S COLORS

- White mat
- Dark brown mat
- Dove-Grey mat
- Special grey

VOK WALL COLORS

- White
- Grey
- Champagne
- Dove-Grey

COMPATIBLE WITH:
Arcadia | Arcadia-K | Eclettica | Qzebo | 3Facile | Kube 90 | Kube 120 | Onda 90 | Onda 120 | Vela 90 | Vela 120

GLASS SHUTTER
sliding glass door closure



STRUCTURE'S COLORS

- White mat
- Dark brown mat
- Dove-Grey mat
- Special grey

ACCESSORIES FOR GLASS WALLS

Lock with knob, key, and latch for lateral opening
Opening on the opposite side "Push-Push"
Fixed wall with windbreak profile
Extra-clear transparent glass

COMPATIBLE WITH:
Arcadia-K | Eclettica | Qzebo | 3Facile

ORNAMENTAL WALL
draping with central opening

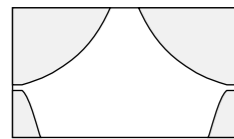

DRAPING'S COLORS

- White
- Champagne
- Dove-Grey

COMPATIBLE WITH:
Qzebo | Kube 90 | Kube 120 | Onda 90 | Onda 120
Vela 90 | Vela 120

CANOPY
corrugated aluminum protection

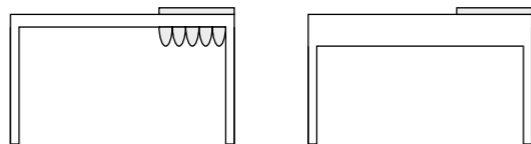
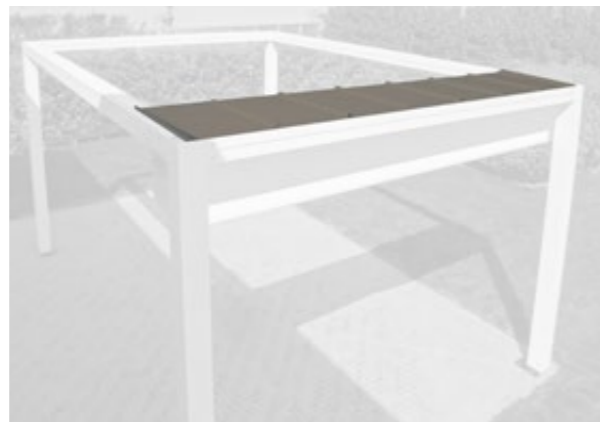

COMPATIBLE WITH:
Arcadia | Arcadia-K | Onda

LIGHTING
strip LED



LED'S COLORS

- Natural white
- RGB

COMPATIBLE WITH:
Arcadia | Arcadia-K | Eclettica | Qzebo
Kube 120 | Onda 120

LED'S COLORS

- Natural white + RGB

COMPATIBLE WITH:
Eclettica

HEADING
infrared heater

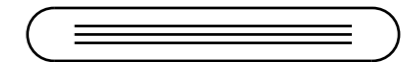

COMPATIBLE WITH:
Qzebo | 3Facile

ANCHORAGE
concrete ballast

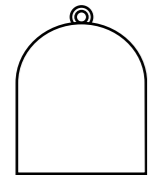

COMPATIBLE WITH:
Qzebo | Kube 90 | Kube 120 | Onda 90 | Onda 120
Vela 90 | Vela 120

ANCHORAGE
white stone grit ballast

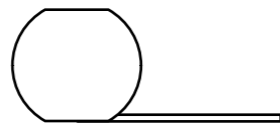

COMPATIBLE WITH:
Velora | Velart

ANCHORAGE
concrete planter

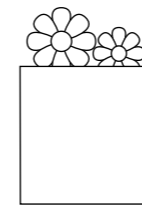

COMPATIBLE WITH:
Qzebo | Kube 90 | Kube 120 |
Onda 90 | Onda 120 | Vela 90 | Vela 120

PERIMETER
gutter

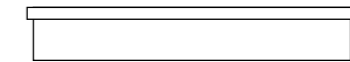

COMPATIBLE WITH:
Qzebo | 3Facile

PHOTOVOLTAIC KIT

Kit to be installed on the roof, designed for storage batteries.

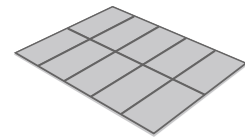

The Kit includes:

- 6, 8, or 10 photovoltaic panels (depending on the required system power, compatible with the structure's surface as indicated in the adjacent table).
- Hybrid inverter with a nominal power of 4 kW.
- 4G Kit with USB for remote monitoring.
- Additional 5 kWh battery pack.

| A (cm) | B (cm) | PHOTOVOLTAIC KIT (kW) | | |
|--------|--------|-----------------------|------|------|
| | | 3,06 | 4,08 | 5,10 |
| 400 | 500 | • | | |
| 450 | 500 | • | | |
| 500 | 500 | • | • | |
| 550 | 500 | • | • | |
| 600 | 500 | • | • | • |

COMPATIBLE WITH:
Eclettica

STANDARD ROOF COVER'S COLORS

| | | Soltis 96 | Soltis W96 | Precontraint 402 | Precontraint 502 Satin |
|-----------|---|-----------|------------|------------------|------------------------|
| White | ○ | 096-8102 | W96-8102 | 402N8104 | 52S-8102 |
| Champagne | ● | 096-1103 | W96-1103 | 402N8341 | 52S-8341 |
| Dove-Grey | ● | 096-2135 | / | / | / |
| Grey | ● | 069-2171 | W96-2171 | 402N1072 | 52S-2171 |

| | | Precontraint 602 (blackout matt finish) | Precontraint 702-S (glossy blackout) | Dacron 391CB |
|-----------|---|---|--------------------------------------|--------------|
| White | ○ | 60250537 | 7028603S | 0001DAC |
| Champagne | ● | 60250539 | / | 0002DAC |
| Dove-Grey | ● | 60250597 | / | / |
| Grey | ● | 60250542 | / | / |

- more colors available upon request

STANDARD STRUCTURE'S COLORS

| | | Smooth glossy finish | Matt-rough finish |
|-----------------|---|----------------------|-------------------|
| White | ○ | ✘ | ✓ |
| Dove-Grey | ● | ✘ | ✓ |
| Dark brown | ● | ✘ | ✓ |
| RAL 9010 | ○ | ✓ | ✘ |
| Anodized silver | ● | ✓ | ✘ |
| Special grey | ● | ✓ | ✘ |

- RAL colors available upon request

WARRANTY AND QUALITY

- The products are CE certified. The booklet with the Declaration of Performance (DOP) accompanies the product until its installation is completed.
- Fireproofing certificates are supplied for each type of tarp.
- The structures are structurally tested and comply with the loads required by current legislations, DM 17 January 2018 Technical Standards for Buildings (Norme Tecniche per le Costruzioni) NTC 2018 and UNI EN 1991
- The structural elements made of aluminum are covered by a 5-year guarantee*
- Since 1990, we design and industrialize our collections completely in Italy, at the Poggio Renatico plants.

* For further details about the warranty please see the terms and conditions of sale Giulio Barbieri S.r.l. indicated in the official price list.

CONTACTS

Giulio Barbieri S.r.l.

Via Ferrara, 41
44028 Poggio Renatico (FE) - Italy
info@giuliobarbieri.it
Tel. (+39) 0532 821511
Fax (+39) 0532 821555

www.giuliobarbieri.it



ADERENTE A
**CONFINDUSTRIA EMILIA
AREA CENTRO**
Le imprese di Bologna,
Ferrara e Modena

The images contained in this catalog belong to Giulio Barbieri S.r.l. Any kind of unauthorized reproduction is strictly forbidden.

The information regarding the Pergole and Vele Giulio Barbieri contained in this catalog may change as a result of the finalization of the commercial offer.

